

**DU**  
series

Power relay series pursuing reliability and safety



DU1PU

■ Currently it is used for such purposes

---

- Power for microwave ovens
  - Control panel, Power supply equipment, Molding equipment, Machine tools, Welding machines, Machinery for agriculture
  - Vending machines, Telecommunications equipment, Disaster prevention equipment, Copiers
  - Commercial equipment, Measuring instruments, Medical devices
  - Various household appliances
- 

DEC is a professional manufacturer of relays

**DEC** Daiichi Electric Co., Ltd.

<https://www.j-dec.co.jp>

# DU series

## ■ Features

- General purpose power relay boasting high reliability and achievement.
- Tab terminals for contact and PCB terminals for coil and contact signal is prepared.
- It is a relay developed with optimum specification for microwave ovens.

## ■ Model numbering system

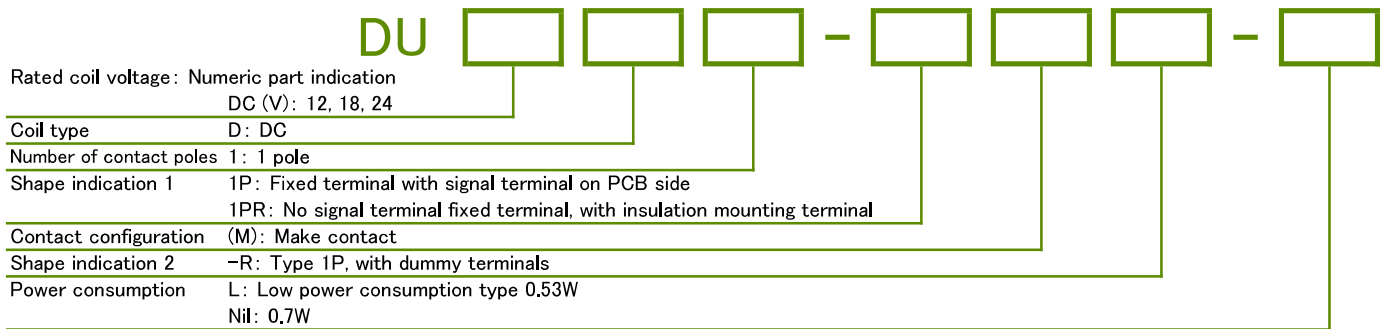

## ■ Safety standards

	Contact rating
UL/cUL	16A 250V AC 20A 125V AC
SEMKO	16A 250V AC
VDE	16A 250V AC $\cos \phi = 1$ 12A 250V AC $\cos \phi = 0.4$
Electrical Appliances and Materials Safety Act	Conformable

## ■ Coil ratings

AC/DC	Item Voltage	0.7W		High sensitivity: 0.53W		Operate voltage (V)	Release voltage (V)	Maximum voltage (V)	Power consumption
		Rated current (mA)	Coil resistance ( $\Omega$ )	Rated current (mA)	Coil resistance ( $\Omega$ )				
DC	12	58	206	44	275	80% max.	10% min.	110%	0.7W/0.53W
	18	38.3	470	29.5	610				
	24	30.8	780	22	1100				

- Notes:
1. Rated current and coil resistance are values at coil temperature of 20°C, tolerance is  $\pm 10\%$ .
  2. Operate voltage and release voltage are values at coil temperature of 20°C.
  3. Maximum voltage is the maximum value of the allowable voltage fluctuation range of the relay coil operating power supply with the ambient temperature at 20°C.

## DU series

### ■ Ratings・Performance

Specifications	Item	Performance	
Contact specification	Contact configuration	1a	
	Contact resistance	30mΩ max. (at DC6V 1A)	
	Contact material	Ag alloy	
Ratings	Rated load (resistive load)	AC250V 16A	
	Max. switching capacity (resistive load)	4000VA	
	Max. switching voltage	AC250V	
	Max. switching current	16A	
Electrical capability	Insulation resistance	100MΩ min. (at DC500V)	
	Dielectric strength	Between coil and contact	AC4000V 1 min
		Between open contact	AC1500V 1 min
	Impulse withstand voltage (between coil and contact)	10 000V min. (1.2 × 50 μs)	
	Operate time (at rated voltage on, at 20°C)	15ms max. (excluding contact bounce time)	
	Release time (at rated voltage off, at 20°C)	5ms max. (excluding contact bounce time)	
Mechanical capability	Vibration resistance	Malfunction	10 to 55 to 10 Hz (double amplitude 1.5mm)
		Destruction	10 to 55 to 10 Hz (double amplitude 1.5mm)
	Shock resistance	Malfunction	100m/s <sup>2</sup>
		Destruction	1000m/s <sup>2</sup>
Life	Mechanical endurance (at 180 times/min)	1 000 000 times min.	
	Electrical endurance (at 20 times/min)	100 000 times min. (at rated load)	
Conditions for operation	Ambient temperature	-25°C to +70°C (no freezing and condensing at low temperature)	
	Ambient humidity	5% to 85%RH	
Mass		approx. 16g	

● Notes: The above is the initial value.

# DU series

## ■ Dimensions

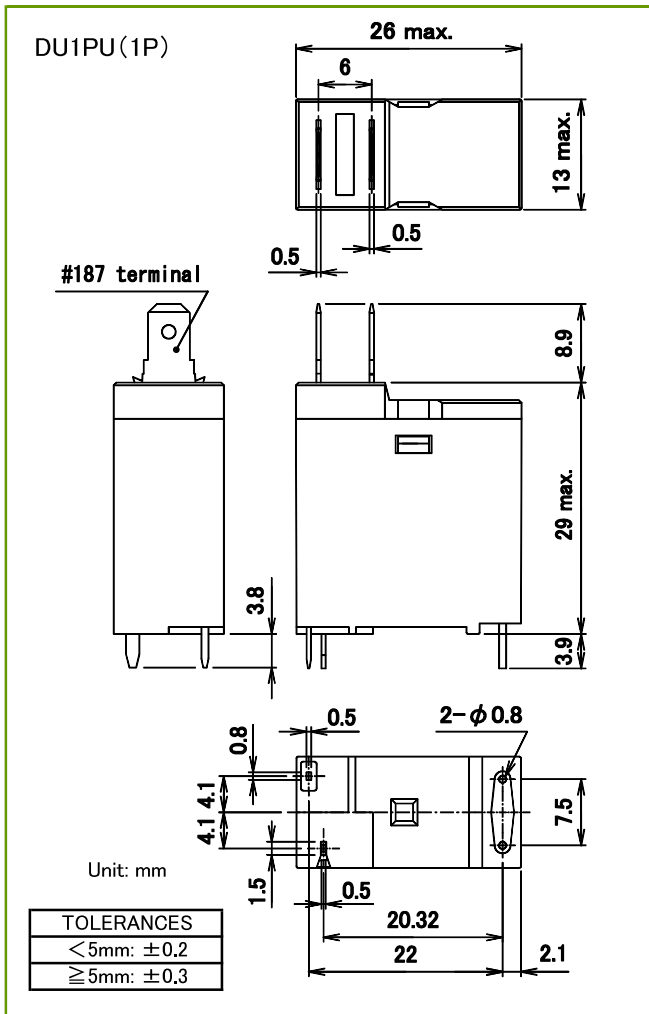

## ■ Dimensions

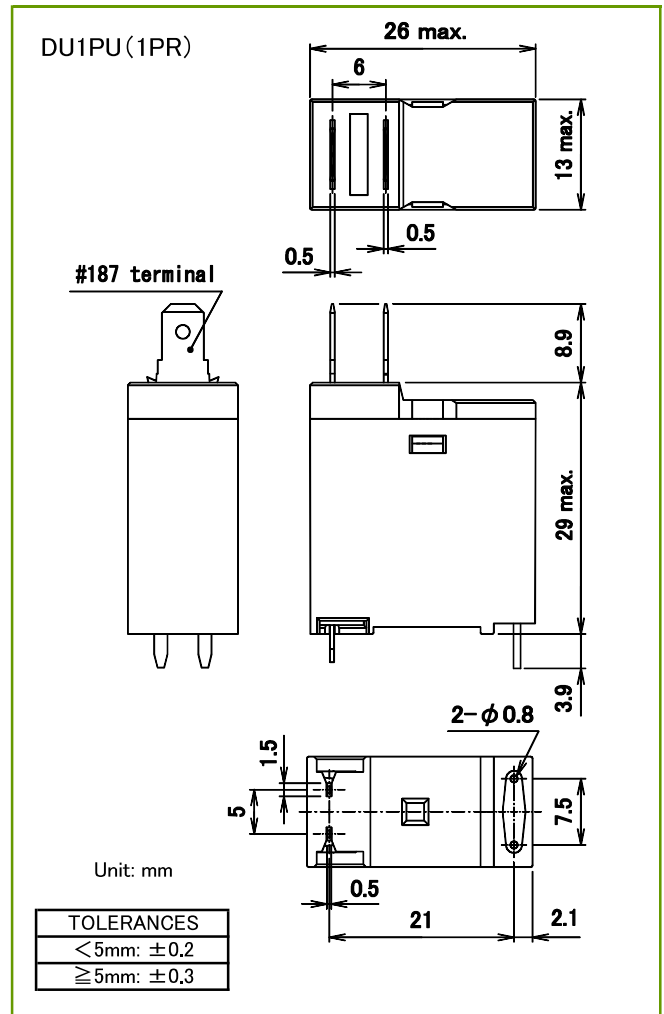

## ■ Schematics

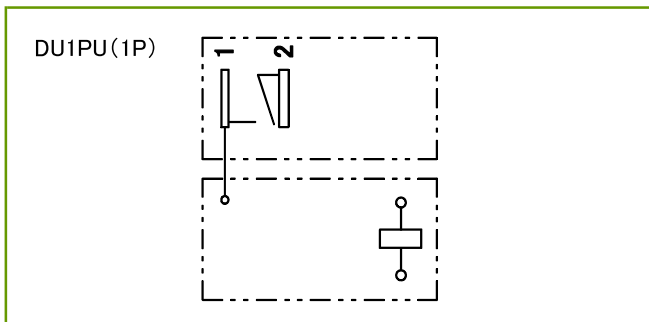

## ■ Schematics

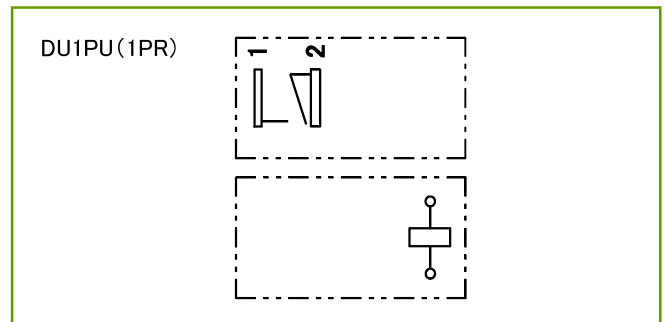

## ■ PCB mounting holes (tolerances ±0.1)

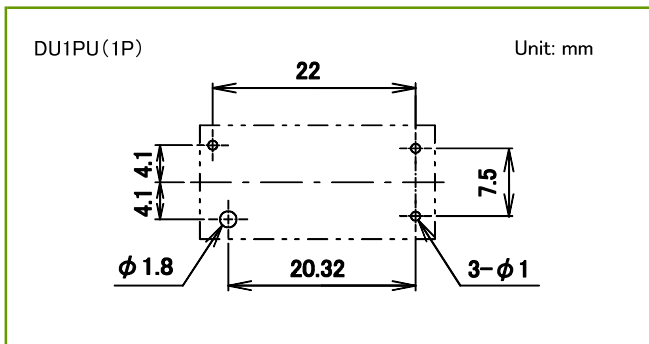

## ■ PCB mounting holes (tolerances ±0.1)

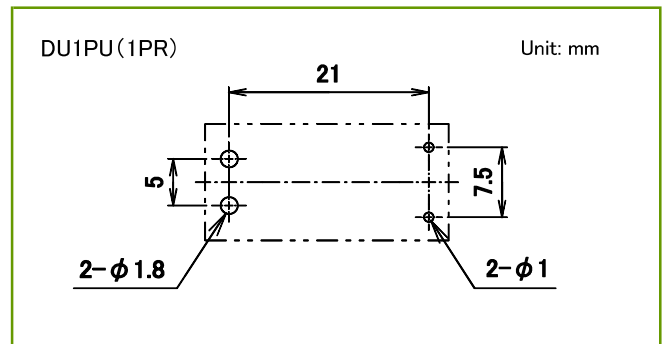

DEC is a professional manufacturer of relays

# DU series

## Reference data

### Maximum switching capacity

DU1PU

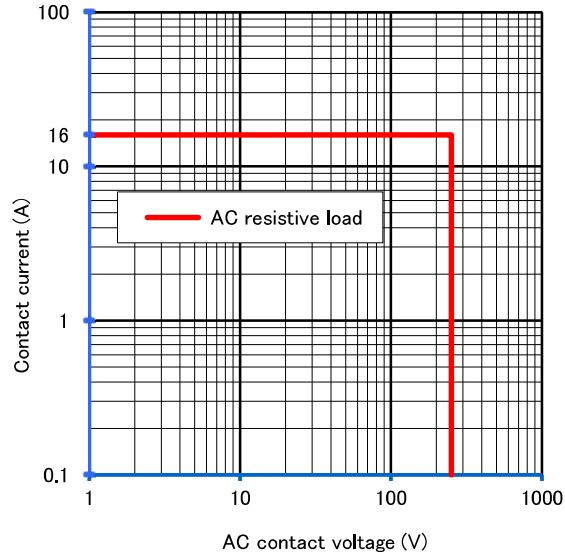

### Durability curve

DU1PU

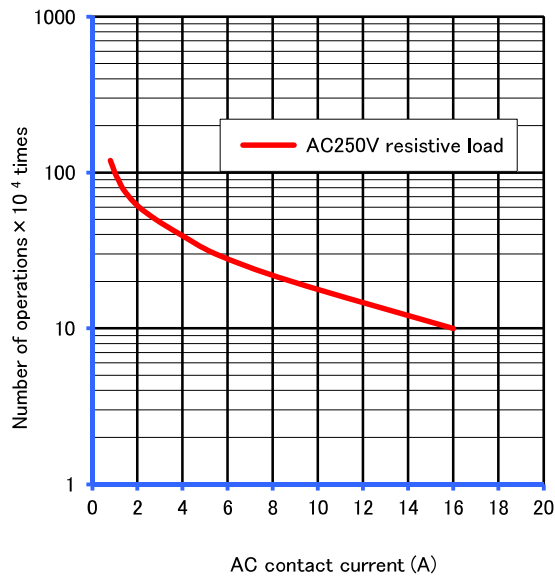

● Please understand that specifications may be changed without notice due to product improvement etc. ● Dimensions and specifications indicate only major points. Please contact our sales representatives for details.

DEC is a professional manufacturer of relays

**DEC** Daiichi Electric Co., Ltd.

Head office 2-2, Noge 3-chome, Setagaya-ku, Tokyo 158-0092, Japan

Phone +81-3-3703-5421

Facsimile +81-3-3703-5426

U R L <https://www.j-dec.co.jp> E-Mail: [sales@j-dec.co.jp](mailto:sales@j-dec.co.jp)

Agency

202308